

Load prioritization technique to guarantee the continuous electric supply for essential loads in rural microgrids

Yaju Rajbhandari^{1,*}, Anup Marahatta¹, Ashish Shrestha^{2,3}, Anand Gachhadar¹, Anup Thapa¹, Francisco Gonzalez-Longatt³, Josep M. Guerrero⁴, Petr Korba⁵

¹Department of Electrical and Electronics Engineering, Kathmandu University, Dhulikhel 45200, Nepal

²Centre for Electric Power Engineering, Kathmandu University, Dhulikhel 45200, Nepal

³Department of Electrical Engineering, Information Technology and Cybernetics, University of South-Eastern Norway, Porsgrunn N-3918, Norway

⁴Department of Energy Technology, Aalborg University, 9220 Aalborg East, Denmark

⁵School of Engineering, Zurich University of Applied Science, DH-8401 Winterthur, Switzerland

*Corresponding: Yaju Rajbhandari (yaju.rajbhandari@ku.edu.np, rajbhandari.yaju095@gmail.com)

Abstract: Microgrid (MG) is one of the practical and best concepts to provide energy access to rural communities, where electric grid extension is not techno-economically feasible. Since the trend of load consumption is not uniform with a low load factor in a rural area, the required rating of the system becomes very high. Similarly, the generation is fixed for these MGs, whereas the load increases continuously over time. Such a system faces supply deficit issues triggering a high number of interruptions that may cause frequent blackouts. Hence, rolling blackout and load clipping techniques are preferred during the peak load period in most of the rural MGs. These issues lead to an unreliable power supply and low satisfaction level of the user. This paper presents the load prioritization technique to guarantee the continuous supply for the essential loads within the rural community. A day-ahead energy allocation technique is mathematically formulated and optimized to maximize the total hours of energy served. This technique maximized the hours of energy served to the load with higher priority followed by the load with lower priorities. From this study, it is found that the proposed strategy helps to improve the hours of energy served in the overall system, by improving the state of charge (SoC) level of the battery system. The result shows that the user satisfaction level has been improved by 5% through 100% of continuity for the essential loads.

Keywords: Demand Side Management; Microgrid; Rural Electrification; Renewable Energy

1. INTRODUCTION

With the increases in energy demand and fixed generation capacity, most of the countries have started to manage the loads using various Demand Side Management (DSM) strategies, where the growing demand has pushed the generation to its limits [1]. DSM technique has been considered as one of the ways to stretch the limits of the system a bit further. It helps in reducing the stress on the existing power grid by balancing the demand and available energy resources locally. This technique of managing demand directly from the load side has already attracted a great deal of attention from research as well as the general communities [2-6]. With an increase in demand, the systems designed for specific load handling capacity are certain to face the issues of voltage and frequency fluctuation that may lead to unreliable energy supply, and even system blackout in some cases [7]. Especially in developing countries, the standalone MGs have played an important role in providing electricity in most of the rural areas [8, 9]. Taking the case of Nepal, more than 55 MW of electricity has been produced from Renewable Energy Sources (RES) like mini/micro-hydropower plants (MHP), solar and wind energy, which fulfils the electrical demand of 3.6 million households [10]. However, different MGs in Nepal face issues on availability, as the average availability of electricity varies from eight hours in a day in minimum for the solar/wind MGs, and up to 23 hours of supply for the Micro Hydropower Plant (MHP) [11]. This indicates a deficit of supply in these rural MGs. Literature shows that researches have been conducted for the design of the reliable system and to reduce the cost through various means like interconnection of MGs [12], optimization of generation technology [7, 13-15], finding the optimal way to share surplus energy between gridlines [7], load management [6, 11]. However, these researches only focus on managing energy from the generation side [16, 17]. Furthermore, the supply of these isolated MGs relies on RESs, where generation itself is on the question of a reliable source.

Generation of isolated RESs like solar and wind are highly fluctuating in nature. Its generation depends upon various factors like weather, temperature, and swing based on climatic change. On the other side, demand also has its own nature that may vary on an hourly, daily basis, and/ or seasonal basis [18]. The demand also depends on occasional events like community and social norms programs, festival season, and environmental factors [19]. The load hinge upon the type of consumers in the region such that industrial and commercial consumer have different demand pattern than the residential consumer [20, 21]. Isolated MGs in developing countries have a common consumption pattern, this is due to the higher number of residential users than other types of consumers. Due to which each year the connection to a new household is guaranteed that leads to an increase in demand. Likewise, consumption in a household in Nepal has been increasing by 38% per year [22]. Increasing the gap between demand

and generation at a rate of 13.3% annually [23]. Due to a significant increase in demand in recent years, the current supply infrastructures are being inadequate, resulting in load shedding during peak hours and eventually the generation systems suffer from various problems [24]. Adding generation to the system could be a solution but this will further increase the cost of energy. However, based on the research done, Isolated MGs in Nepal are already facing problems on revenue generation due to high operation and maintenance costs [24]. With the development of new technologies, the current energy market has introduced a smart concept that provides the opportunities to understand the load consumption from the user perspective. In the current world, the energy systems are getting smarter, which can help in the optimizing uses of energy concerning through the demand side without affecting the user comfort and satisfaction. Concept of smart load control to shed or/ and reduce the consumption of the load appliance, which can reduce the peak demand by 30%, and its implementation can help to reduce the grid's operation costs and increase the system reliability [2].

DSM strategy for managing the loads includes everything that can be done in the demand side of an energy system [1]. This strategy of load management ranges from replacing the high-demand load equipment with a lightweight load to installing a complex load management controller. These strategies can be categorized based on their impact and the time-based solution that they can provide to the electrical system. With the implementation of a smart system, commonly used techniques focus on altering the load profile to keep the balance between load and supply. With the customers' permission, the DSM can change the load shape of the load by reducing the total demand of the user, during peak hours through shifting or shedding. Six broadly discussed and implemented techniques on DSM include; peak clipping, valley filling, load shifting, load building, strategic conservation and strategic load growth [5]. The strategies can be implemented by analyzing the system's load profiles of the user to manage peak demand, reduce the cost of energy, conserve energy for strategic load managing, and in some cases even to increase demand [3]. To shift, shed or adjust the consumption, understanding these loads becomes very important. Studies tend to perform the load classification based on user preference, energy demand, and flexibility [6, 11]. As loads are the appliances being used in each household, researchers classified the appliances as static and dynamic [25], shed-able and unshed-able [6], critical and uncritical [26], programmable and dimmable load [2], and so on based on their power consumption and behaviour of their use. Performance analysis of these loads of individual home-based appliances helps to achieve the good demand response of the energy management system [3]. Through the control of appliances, the demand curve can be shaped by reducing the total load on the distribution system during peak periods, and shift the load in a better time. The direct control of load has an effect on user comfort and might question the satisfaction level that the system can provide. Hence proper prioritization of appliances either in terms of time-based and device-based strategies can help to achieve maximum user comfort in the defined budget limit [25]. In [26], the classified load is further divided into priorities given to each appliance where the system shed and shift load to satisfy the demand. This load control is driven by the kVA rating of each piece of equipment, and dividing the loads into the base and shed-able load, with control of combined heat and power (CHP) equipment as the shed-able load can keep the demand below the targeted load while maintaining user comfort [6].

Considering the demand study conducted in Nepal [11], a framework on prioritization of load has been presented, which is based on the user's preference and storability of the load. This classification of load helps to improve user satisfaction [25]. With classification on each load, identifying the control mechanism and the proper load shedding/ shift time is also equally important. However, a question on what basis the control action must be performed should be answered, e.g. various strategies are implemented such as: to reduce the cost of energy for individual consumer [5], to perform peak shaving, or to minimize carbon emission [27], to maintain battery life [28], etc. DSM strategies with optimization processes such as Heuristic Optimization [5], Genetic Algorithm Optimization, Hybrid Bacterial Foraging [29], Whale Optimization [30], and Fuzzy Logics [31] are implemented to find the optimal point for timely control action to maintain user satisfaction at the same time. However, these techniques require high computational speed and programming skill, which is a lot to ask for as simple energy management systems such as found in rural locations. Controlling each appliance is not an easy task, as every equipment needs to be connected to the controller through cable or communication, especially in rural area. A simple control system implemented in Bhutan uses the light indicator to indicate the health of the grid and prevent the use of the heavy appliance in households during peak hours [32]. Similarly, a management strategy has been implemented on a solar MGs in Baidi, Nepal, which adopted package-based system that provide three different levels of packages based on user demand and affordability [33]. With the limited generation capacity of isolated MGs, the priority-based load control strategy comes in popularity in such remote locality.

This paper presents a day ahead DSM strategy which can be used in MG relying on an ESS for uninterrupted power supply. It uses load shedding techniques and controls the appliances through the smart meter on the household level. Following the complexity in controlling the load, this research put up an idea to conserve the energy for loads that are prioritized by the consumers for shedding and can help to increase the reliability of the system via automatic control with a simpler search algorithm that allocates optimum energy for different levels of loads. For a healthy operation, the proposed method traces the working

pattern of each appliance in each household based on the three different levels of priority. The individual smart controller is adjusted to follow the consumption characteristics of the appliances in each level avoiding the requirement for a system to control and communicate with each appliance. The technique follows an exhaustive search algorithm allowing the central controller to identify the optimum point of shedding of lower priority load for better user satisfaction. This research article is further organized as follows: Section 2 describes the demand and generation study in the case of MGs in Nepal followed by a mathematical model development for simulation and discusses the proposed algorithm. The results and outputs of the simulation are presented in Section 3, and Section 4 provided the summary of the findings.

2. METHOD AND MATERIALS

2.1. Case scenarios

Lack in the generation or higher electricity demand can lead to a supply deficit, reducing the availability of system supply for hours. In the case of a system relying on RES like solar and wind energy, the generation faces major fluctuation as load. The change in climate and surrounding temperature could reduce the generation significantly. Isolated MGs in Nepal has major two sources of generation (i.e. solar and MHPs). Generation in MHPs have a variation in a long-time frame as variation in the generation is affected based on location and season change. Whereas the solar has a high fluctuating nature. Uncertainty of the solar generation might occur at multiple periods, ranging from a few minutes to a few hours and even in some cases to days ahead [34]. A one-year graph of solar generation (i.e. generation by 800 W solar PV) for a random location of Nepal can be seen in Figure 1. From the variation is observed in the Figure, the generation of a system can decrease up to 35 %, and can last up to two days straight. A seven days sample has been highlighted to shows the generation pattern over one week. To maintain continuity in the supply solar-based MGs have Energy Storage System (ESS) as a backup.

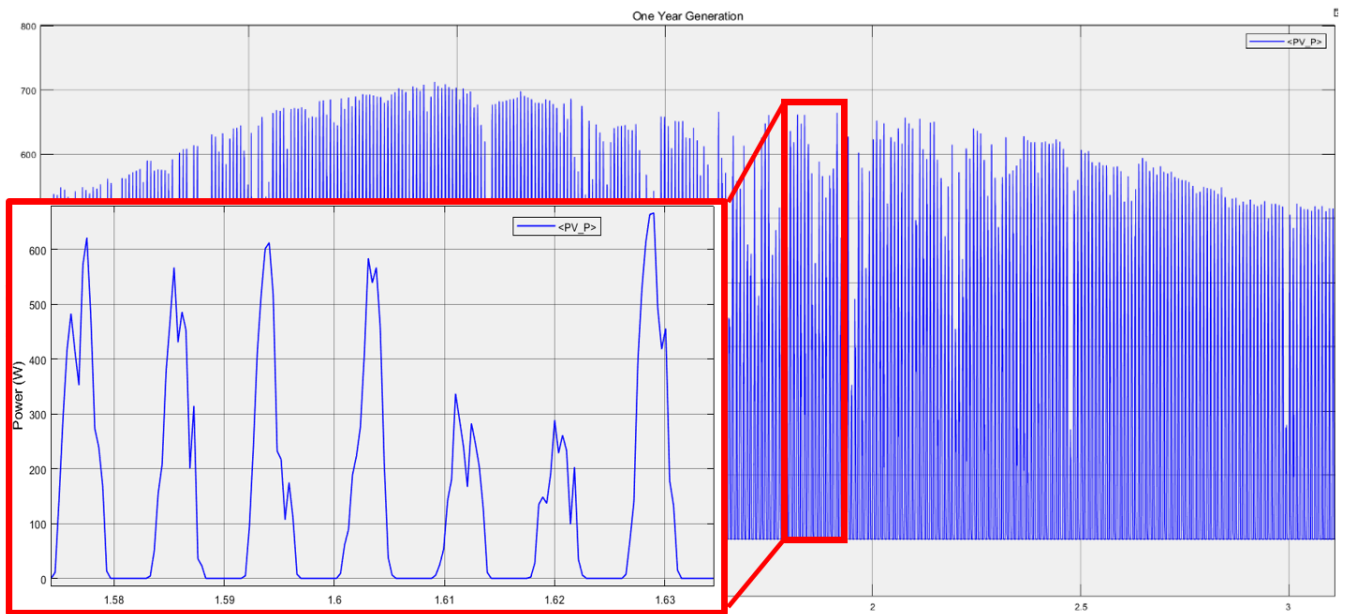

Figure 1: One-year PV generation (7 days low generation study)

On the other side, the potential appliances that can be connected to solar-based MGs were identified via a survey study for the Nepalese MGs and presented in Table 1 [11]. The study considered 13 major appliances that are used in the isolated solar MGs in Nepal. In this study, the load consumption has been scaled for one particular household with a maximum demand of 725W and average energy demand of 4.5 kWh per day. All of the appliances are categorized into 3 different levels based on their priority in the daily life of consumers. The highest priority of load consists of the appliances, which are required on an hourly basis, whose importance cannot be neglected, their service of hours should always be maximum (i.e. no interruption throughout the day). Similarly, the second or medium priority load consists of the load appliances used for entertainment and information purposes, like a TV set, Radio, Laptops, and has lower energy consumption. Finally, the lowest priority is given to the equipment whose demand is high and are used to improve life standards like woofers, VCRs and Oven, Fridges, etc. In Figure 2 (a), the hourly uses of these appliances within a household can be observed. Similarly, Figure 2 (b) presents the same consumption based on different priority levels. It can be observed that the appliance-based study can be simplified when they are classified. The residential demand for the simulation has an average demand of 4.8kWh per day. Here, the highest priority load covers 32.36%, second or medium

covers 35.28%, and lowest priority covers 32.36 % of the total load respectively. From Figures 2 (b), it can be observed that the first priority load has a continuous demand throughout the day, whereas the second priority load has at least 12 hours demand period, and the load with the least priority has an average of 6 hours demand period per day.

Table 1: Prioritization of load demand

| Appliances | Power (W) | Quantity (nos.) | Total Power (W) | ToU of appliances per day | Priority | Time of Operation of Each priority |
|------------------------|-----------|-----------------|-----------------|---------------------------|---------------------------|------------------------------------|
| Light Internal A (CFL) | 15 | 4 | 60 | 9 | Higher Priority (Level 3) | 24 |
| Light Internal B (LED) | 10 | 4 | 40 | 13 | | |
| Mobile phone | 15 | 2 | 30 | 6 | | |
| CDMA Receiver | 15 | 1 | 15 | 24 | | |
| Rechargeable light | 10 | 2 | 20 | 6 | | |
| Television | 150 | 1 | 150 | 5 | Medium Priority (Level 2) | 12 |
| Fan | 75 | 1 | 75 | 5 | | |
| Laptop | 70 | 1 | 70 | 10 | | |
| Radio | 10 | 1 | 10 | 5 | | |
| VCR | 50 | 1 | 50 | 3 | Lower Priority (Level 1) | 6 |
| Woofer | 100 | 1 | 100 | 3 | | |
| Exhaust fan | 60 | 1 | 60 | 3 | | |
| Computer | 200 | 1 | 200 | 3 | | |

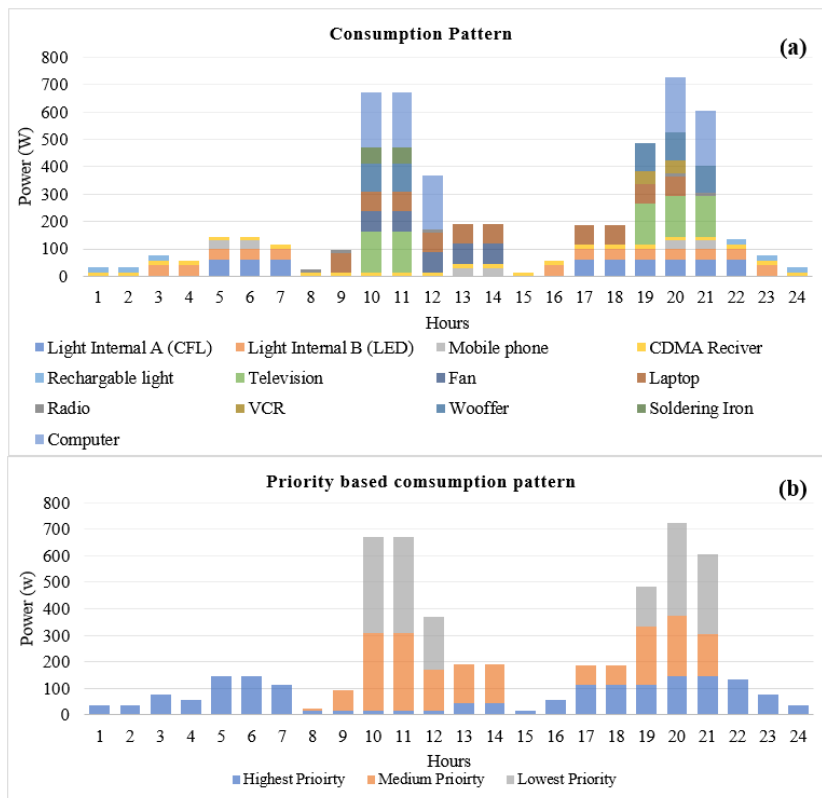

Figure 2: (a) Consumption pattern on appliance level, (b) Consumption pattern based on priority

2.2. Problem Formulation

Generally, the prioritization techniques help to improve the user comfort and satisfaction of the services [25]. This allows the user to run the selected appliances for higher periods as a trade-off with giving up lower priority appliances to avoid blackout on the system. The proposed strategy sheds the connection of supply based on load priority in a way to maximize the hours of load-served for the load with the highest priority. The load shedding technique for such applications can be tested through a model-based simulation to observe the hours of load demand served. Mathematically, the ratio of the hour for services can be calculated with the help of Equation 1. Here, $P_{Served\ hours}$ is the total hours of power served, and $P_{Demand\ hours}$ are the value for hours for power demanded obtain through simulation of the solar MG model. N defines the total number of equipment as n shows the appliances in function. During the priority set, n defines all of the appliances considered within the specific priority. Since the hours of power served for all of the appliances must be maximized, load priority may change from user to user. By observing the total hourly demand of each priority level, the values of x , y , and z are set, which defines the priority of each appliance. Considering the three different appliances Load A, Load B, and Load C with hourly consumption per day as $t1$, $t2$, and $t3$, the priorities are set by using Equation 2.

$$\sum_{n=1}^N \frac{P_{Served\ hours}(n)}{P_{Demand\ hours}(n)} \quad (1)$$

$$x = \frac{t1}{t1+t2+t3}, y = \frac{t2}{t1+t2+t3}, z = \frac{t3}{t1+t2+t3} \quad (2)$$

Here, x defined the priority set of Load A, y for Load B, and z for Load C. The user's satisfaction is calculated based on hours of energy-served and total energy-served on each priority set. Maximum user satisfaction is obtained when the cumulative product of priority set and ratio energy served to energy demand tends to 1 as shown in Equation 4 (i.e. when all of the demand is served). However, as the available energy decreases, this value will be hard to obtain. So, the system must identify the optimal point where the least priority load can be shaded without affecting the hours of energy served on other loads.

$$x \frac{EnergyServed(n-1)}{EnergyDemand(n-1)} + y \frac{EnergyServed(n)}{EnergyDemand(n)} + z \frac{EnergyServed(n+1)}{EnergyDemand(n+1)} = Users\ satisfaction \quad (3)$$

$$User\ Satisfaction \leq 1 \quad (4)$$

2.3. System Architecture

To implement DSM based strategy in a simulation environment, the system considers two modes of control: a central controller at the generation point, and a remote load-controlling agent (smart meter) for each consumer. The remote controller monitors the characteristics of the load, which contains both way communication channels that send the dynamic data. It is designed to receive the cut-off points as the controlling command from the central controlling unit. The remote controllers contain three supply points as shown in Figure 3, which is designed to adjust or shed the load at an optimum point. The optimal points for load cut-off are identified using an exhaustive search algorithm which is discussed in section 2.4. The data of load consumption and cut-off signal are handled through the communication setup in the system. GSM, CDMA, IOT are the common mode of the communication protocol for smart metering purposes in most of the developing countries [35]. Whereas, reliability and availability of the communication do not fall under the scope of the research. Hence, as shown in Figure 3, the system architecture depends on two-way communication between the smart meter and central controller to implement the proposed DSM strategy. Generally, the signal is sent from the central controller, which defines the level of shedding to be implemented, and a signal from the remote controller contains the priority-based load data for monitoring and control application. Each smarter meter receives the shedding signal based on which it shed the load on every household.

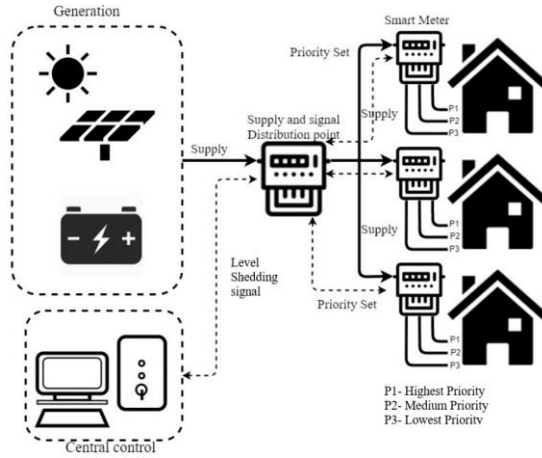

Figure 3: System architecture of the proposed model

The implemented search algorithm aims to identify the optimum point of SoC of the ESS to shed the load on the required level such that the higher priority load gets an uninterrupted supply. With the classification of load in section 2.1, the shedding can be performed to increase the availability of the stored energy for the higher-prioritized load. Figure 4 shows the overall workflow of the system based on the proposed architecture, the central controller receives the initial SoC level of ESS, predicates generation and demand, using which it identifies an optimum SoC as threshold point through the search algorithm. The flow of the search algorithm is further discussed in section 2.4. This process of identifying the optimal threshold point is performed at the beginning of a defined control period. The optimum threshold points are the input variables of real-time load control. Real-time load control is introduced to keep a continuous track of the state of charge of the battery and send the signal to the remote controller when the SoC goes below defined threshold limits. Similarly, in case the battery is charging and SoC exceeds the threshold the reconnection signal is sent. In such a case flicking of signal might occur, connecting and disconnecting the load frequently. To avoid flickering in the system a hysteresis band is implemented such that the connection of supply is restored only when the SoC exceeds 5% of the defined threshold for each priority. The bandgap can be set a per the system capacity to handle generation and demand. Figure 5 presents the flowchart of how the shedding of the load is achieved in the proposed architecture through real-time load control. Here in figure5, threshold 1 defines the SoC below which the load with the lowest priority is shredded, threshold 2 defines the point of SoC below which medium and lowest priority loads are shedded, and finally DoD is the Depth of discharge of the battery below which all load is shedded.

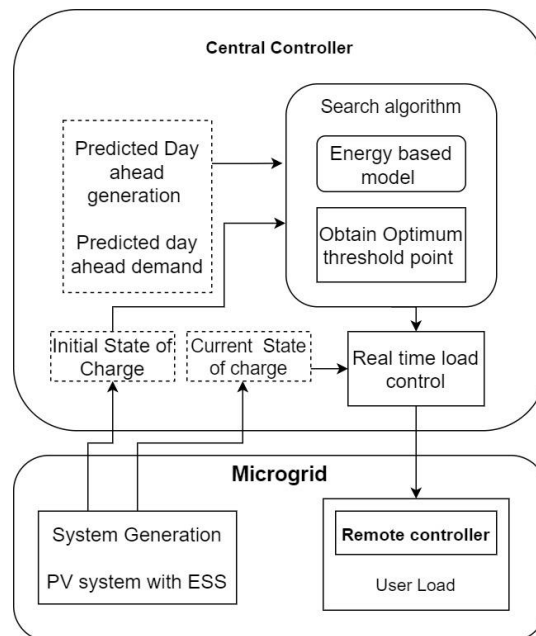

Figure 4: Work flow

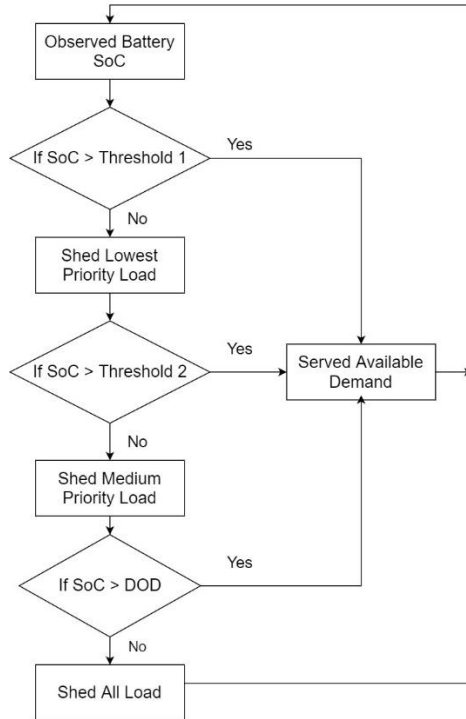

Figure 5: Real-time load control action flowchart

2.4. Proposed Search Algorithm

The search evaluates the point to find the best user satisfaction which depends upon the available energy in the storage. As the SoC of ESS is dynamic though out the day, a model-based analysis must be performed. The heuristic-based searching algorithm like genetic, particle swarm, whale optimization is commonly used to find the best point or position in these type of research sectors [29, 30]. However, these algorithms are suitable to be used for a large search area, whereas in the proposed case area, an exhaustive search shows a higher advantage over other algorithms as our search portion is smaller. The area of search has been reduced by categorizing the load in three levels. Exhaustive search finds two optimum points (i.e, Threshold 1 and Threshold 2) on an SoC of ESS, which ranges from maximum to minimum SoC. The algorithm checks every possible solution that should be considered as an effective and efficient output. The best solution is defined by user satisfaction as discussed in section 2.2 as the objective function of this search algorithm.

To improve user satisfaction, the proposed algorithm adjusted the shedding point of the specified load that maximizes the hours of the energy served. The algorithm uses 48 hours (considering 2 days autonomy), and predicates the data to identify the maximum hours that load with the highest priority can be served with available energy by changing the threshold point from SoC_{min} to SoC_{max} . Once the hours of energy served for load with the highest priority are maximized, the same approach will be followed for others. Set1 and Set2 are the thresholds for battery level that is defined for level 1 and level 2 shedding. With the optimal threshold points for potential load shedding, the system then observes the battery level on a real-time basis to shed the respective priorities. F_{H1} , F_{H2} , F_{H3} indicates the final hours of energy served for load with priority 1, 2, and 3. Similarly, the T_{H1} , T_{H2} , T_{H3} suggest the measurement of test value obtained for hours of energy-served. The steps of the proposed algorithm are given below. The significant advantage of the purposed algorithm is it improves the availability of energy from the load with the highest priority. The flexibility of the algorithm allows the system to maintain the load profile pattern by adjusting the hourly use of lower priority load.

Algorithm

Define Threshold values for each priority

$FF_{H1} = 0$, $FF_{H2} = 0$, $FF_{H3} = 0$

For Threshold1 < 100 %Priority 3 threshold value

For Threshold2 < 100 %Priority 2 threshold value

if Threshold1 > Threshold2 %priority 3 should be shedded before Priority 2 cannot be shedded together

Energy based Model Simulation (PredictedLoad, PredicatedDemand, InitalSoC)

```

Obtain the value T_H1, T_H2, T_H3 though modeling simulation
if T_H1 > FF_H1      %maximize Hours for Load 1
    FF_H1 = Present_H1;
    Update F_Set1, F_Set2 with Threshold1, Threshold2
elseif T_H1 == FF_H1
    if T_H2 > FF_H2      %maximize Hours for Load
        FF_H2 = Present_H2;
        Update F_Set1, F_Set2 with Threshold1, Threshold2
    elseif Present_H2 == DayFinal_H2
        if Present_H3 > DayFinal_H3 %maximize Hours for Load 3
            FF_H3 = Present_H3;
    elseif Present_H3 == DayFinal_H3
        maximize energy saving %Select higher value of threshold
        Calculate User Satisfaction;
    Update F_Set1, F_Set2 with Threshold1, Threshold2
Threshold1 = Threshold1 + 10
Threshold2 = Threshold2 + 10
End all

```

User satisfaction indices concerning change in threshold point are as shown in Table 2. The threshold point is checked for every 10% change in SoC. The user satisfaction ranges from 0 to 1, as zero defines 0% of user satisfaction and 1 for 100% of user satisfaction. For table 1, we can observe that Set 1, 0.7 show the lowest priority that will be shedded when SoC reaches 70%, and for Set 2 level at 0.6 shows that the medium priority load will be shedded when SoC reaches or goes below 60%. Among multiple choices, the algorithm compares the threshold point with the highest energy-saved for the system. From the table we can observe the choice for Set 1 ranges from 40% to 70%, and that for Set 2 ranges from 30% to 60%, since the maximum energy is stored when the load is shed at 70% and 60% SoC.

Table 2: Optimum threshold identification using exhaustive search

| Threshold | | Set1 | | | | | | | | | User Satisfaction |
|-----------|-----|------|-----|-----|-----|-----|-----|-----|------|------|-------------------|
| | | 0.1 | 0.2 | 0.3 | 0.4 | 0.5 | 0.6 | 0.7 | 0.8 | 0.9 | |
| Set 2 | 0.1 | - | - | - | - | - | - | - | - | - | - |
| | 0.2 | - | - | - | - | - | - | - | - | - | - |
| | 0.3 | - | - | - | 1 | 1 | 1 | 1 | 0.97 | 0.86 | 0.86 |
| | 0.4 | - | - | - | - | 1 | 1 | 1 | 0.97 | 0.86 | 0.86 |
| | 0.5 | - | - | - | - | - | 1 | 1 | 0.97 | 0.86 | 0.86 |
| | 0.6 | - | - | - | - | - | - | 1 | 0.97 | 0.86 | 0.86 |
| | 0.7 | - | - | - | - | - | - | - | 0.96 | 0.86 | 0.86 |
| | 0.8 | - | - | - | - | - | - | - | - | 0.85 | 0.85 |
| | 0.9 | - | - | - | - | - | - | - | - | - | - |

2.5. Modelling of PV Generation and Storage

For the system to be stable, the demand must match the supply. Condition for an independent energy system, the relation can be expressed as in Equations 5 and 6. The technique of load management is tested for an independent PV system with the ESS. So, the major components of this system are the PV solar cell, batteries, user loads, power electronic converters (PEC), battery charging unit, whereas the detailed description on the modelling of the generation and storage are presented here in this study. The model depends on maintaining the balance between demand and supply. Condition for an independent microgrid can be expressed as in Equations 5 and 6.

$$P_{load} + P_{Loss} = P_{supply} \quad (5)$$

$$P_{supply} = P_{Generation} + P_{storage} \quad (6)$$

2.5.1. Generation Modeling

The PV generation has been modelled based on linear relation to ambient temperature and the radiation of the PV panel. The parameters are obtained from information available from the manufactures datasheet for Nominal Operating Cell Temperature (NOCT) and Standard Test Condition (STC) as listed in Table 3. To introduce more realistic output power from the system, a proper cell temperature at the defined radiation has been considered, for which the NOCT has been used to obtain the generation of the PV panel. As the panel operates at a higher temperature than that of air temperature (T_{air}), so, Equations 7 is used to calculate the operating temperature of the panel. Similarly, Equations 8 and 9 are used to determine the output power and energy from the PV panel. Here, P_{pvmax} is the maximum output power at the presented temperature (T_{air}) and radiation (G_T). The $P_{pvmax,STC}$ is the maximum power of the PV cell at standard test condition, and γ is the temperature coefficient of power usually given by the manufacturer. The $T_{panel,STC}$ indicates panel temperature at the standard test condition in the equation.

$$T_{panel} = T_{air} + \frac{G_T}{G_{NOCT}} * (T_{NOCT} - 20) \quad (7)$$

$$P_{pvmax} = [P_{PVmax,STC} * G_T * [1 - \gamma * (T_{panel} - T_{panel,STC})]] \quad (8)$$

$$E_{pv} = P_{pvmax} \cdot \Delta t \quad (9)$$

Table 3: STC and NOCT Parameters

| Parameters | Value |
|-------------------------------------|----------------------|
| Ambient Temperature (T_{NOCT}) | 20°C |
| Radiation (G_{NOCT}) | 800 W/m ² |
| STC Temperature ($T_{panel,STC}$) | 25 °C |
| MPP at STC ($P_{PVmax,STC}$) | 800W |

2.5.2. Storage Modeling

The actual demand of the system depends upon the efficiency of power energy converters (PECs) and the operated appliances. However, considering the efficiency of each appliance is not possible. Therefore, the model only considers the efficiency of PECs. The power demand of various appliances considered at the instant time “ t ” is given by Equation 10. Here, $E_{demand}(t)$ is the energy demand, $Power_{Appliance}(i)$ is the power demand of i^{th} appliance and n define the number of appliances. The power demand of each appliance has been discussed in Table 1. The limit to the energy demand is defined by the capacity of the inverter. Consider $P_{inverter}^{max}$ to be the maximum power following through the inverter, the energy flow through at a time interval of Δt can be calculated by using Equation 11, which is the maximum energy that can flow through the inverter for Δt time period. For this system, the demand and generation define the charging and discharging of the system, where $E_{PV}(t)$ is the energy generated by PV in the time range (t), $\eta_{Inverter}$ defined the energy efficiency of the inverter.

$$E_{demand}(t) = \sum_{i=1}^n Power_{Appliance}(i) \cdot \Delta t \quad (10)$$

$$E_{inverter}^{max} = P_{inverter}^{max} \cdot \Delta t \quad (11)$$

$$E_{demand}(t) = \begin{cases} \Delta E_{inverter}^{max} & \text{if } E_{demand}(t) \geq E_{inverter}^{max} \\ E_{demand} & \text{if } E_{demand} < E_{inverter}^{max} \end{cases} \quad (12)$$

$$\Delta E(t) = E_{PV}(t) - \frac{E_{demand}(t)}{\eta_{Inverter}} \quad (13)$$

Similarly, Equation 14 identifies the limitation of the battery system, where the SoC indicates the state of charge of the battery, as the modelled battery’s SoC should be in between the maximum and minimum limits. However, the battery’s SoC can reach its limit within a few hours or even in minutes if the discharging or charging energy is very high. The system considers the inverter capacity and charger controller capacity that limit the energy flowing through the battery. To limit the energy flow within the battery, two conditions are considered for the charging and discharging modes. The rate of charging and discharging energy can be calculated by using Equations 15, 16, 17, and 18. Where, $\Delta E_{Charging}^{max}(t)$ is the maximum charging energy, $BESS_{size}$ is the

battery size and TSH is the total sun hours depending upon the location of the system. Similarly, Δt is the defined period for which the energy calculation is conducted. In some cases, the TSH can be an unidentified term where charger capacity is defined. Similarly, for the discharging mode of the battery, the maximum power flow of the battery is defined by the inverter capacity. During the nighttime and/ or cloudy day, the whole system depends upon the battery, which is considered by Equation 12 through limiting the demand.

$$SoC_{max} \geq SoC \geq SoC_{min} \quad (14)$$

$$\Delta E_{Charging}^{max}(t) = \frac{BESS_{size}}{TSH} \cdot \Delta t \quad (15)$$

$$TSH = \frac{BESS_{size}}{\Delta E_{Charging}^{max}(t)} \cdot \Delta t \quad (16)$$

Where,

$$E_{Charging}^{max}(t) = P_{charger}^{max} \cdot \Delta t \quad (17)$$

$$\Delta E = \begin{cases} \Delta E_{Charging}^{max}(t) & \text{if } \Delta E \geq E_{Charging}^{max}(t) \\ \Delta E(t) & \text{if } \Delta E \leq \Delta E_{Charging}^{max}(t) \end{cases} \quad (18)$$

Further, the energy flow takes place through the charge controller, depending upon the available storage in the battery. Hence, the protection of the battery system from overcharging and over-discharging is necessary. As the battery SoC cannot be reached to 200% of its limit, the stored energy within a defined period is limited by the charge controller. Here $\Delta AE(t)$ is the available energy stored in the battery system. The SoC_{max} may change in longer duration, but the simulation is done for a shorter duration, so the change in SoC_{max} is neglected and SoC_{max} is consider as constant.

$$\Delta AE(t) = SoC_{max} - SoC(t) \quad (19)$$

$$\Delta E = \begin{cases} \Delta E(t) & \text{if } \Delta E(t) \leq \Delta AE(t) \\ \Delta AE(t) & \text{if } \Delta E(t) > \Delta AE(t) \end{cases} \quad (20)$$

Similarly, in the case when the ΔE is negative (i.e. discharging mode), the battery is protected by the conditions as provided by Equations 21 and 22.

$$\Delta AE(t) = SoC(t) - SoC_{min} \quad (21)$$

$$\Delta E(t) = \begin{cases} \Delta AE(t) & \text{if } \Delta E(t) \geq \Delta AE(t) \\ \Delta E(t) & \text{if } \Delta E(t) < \Delta AE(t) \end{cases} \quad (22)$$

Based on the case considered in section 2.1 the parameter that defined the storage model can be seen in Table 4. The parameter of inverter and storage are considered based on the daily consumption pattern of the load, total demand per day, and the total number of days of autonomy the system is designed to handle.

Table 4: Parameter set for Storage model

| Parameter | Value |
|----------------------|---------|
| $P_{inverter}^{max}$ | 800W |
| SoC_{max} | 100% |
| SoC_{min} | 20% |
| $BESS_{size}$ | 8500 Wh |
| $P_{charger}^{max}$ | 1000 W |
| $\eta_{Inverter}$ | 90% |

3. SIMULATION RESULT AND DISCUSSION

This section presents the simulation data and discusses the working of priority based DSM strategy in a different scenario. For the study, simulation is performed for days with lower generation as discussed in section 2.1. To show the working of the proposed strategy simulation is performed for the system with and without the demand side management. Figure 6 shows the overall demand of the system through the seven days considered for the simulation. Here, P1, P2, and P3 represent the highest priority, medium priority, and lowest priority load. Throughout the period total demand of each load P1, P2 and P3 are, 12.13kWh, 13.11 kWh, and 12.05 kWh.

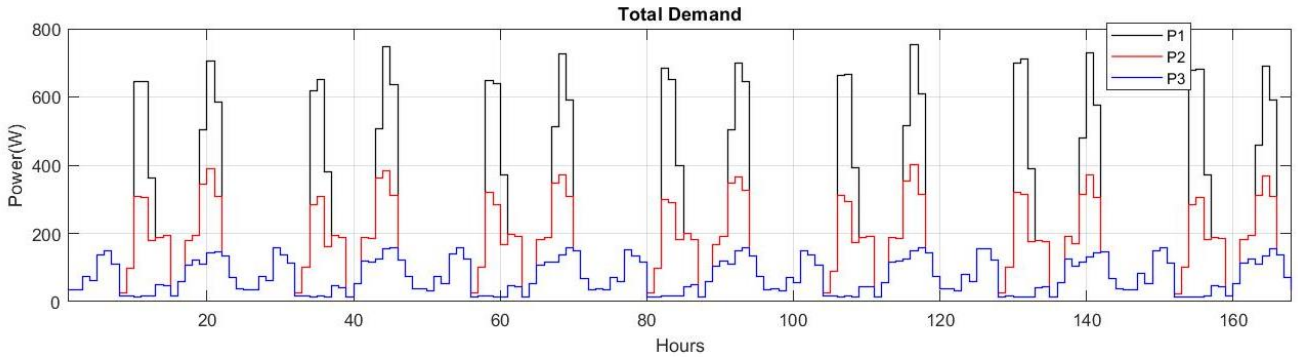

Figure 6: Energy demand for 7 days period

During the lower generation period, the system is unable to serve the complete load. Seven days load served by the microgrid without DSM implemented can be seen in Figure 7 (a). Based on the parameter considers for the microgrid generation and storage Figure 7 (b) shows the total generation and change in battery percentage of the system. It can be observed that the system faces complete shutdown twice on two days on the 5th and 6th day, due to lower generation the storage drains out leading to the blackout during that period. The system faces a total of 5 hours of blackout on the fifth day followed by 12 hours blackout on the sixth day and 4 hours on the seventh day with a total of 21 hours blackout throughout the week.

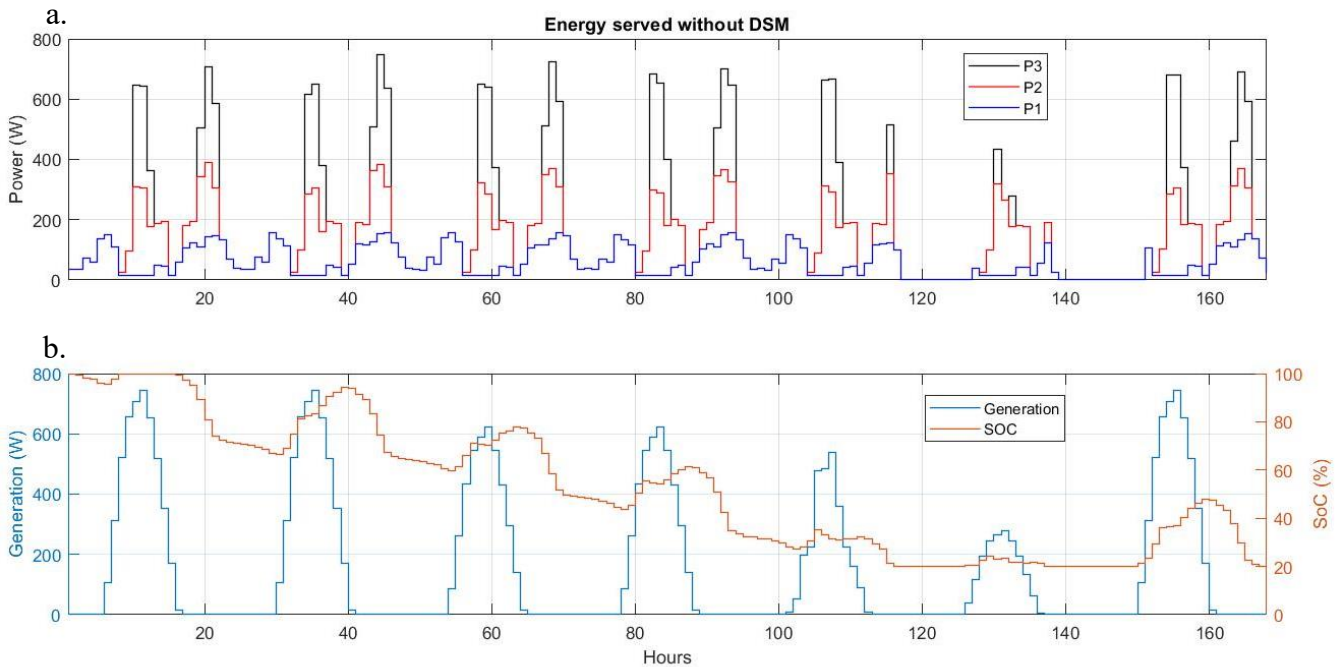

Figure 7(a): Energy served Without DSM strategy, (b) Battery vs Generation

Figure 8(a) show the load served for different priority load for the system with the implementation of proposed DSM strategy. From Figure (b), we can observe that with the implementation of DSM, the battery percentage is kept above 20% such that the highest priority load is served throughout the period. In comparison to the system without DSM strategy, implementing DSM

allows the system to maintain supply to an important load, as P1 Load is served throughout seven day period. From Figure 8(a) we can see that P3 the lowest priority load is completely shedded day during lower generation along with partial shedding of the load medium priority load.

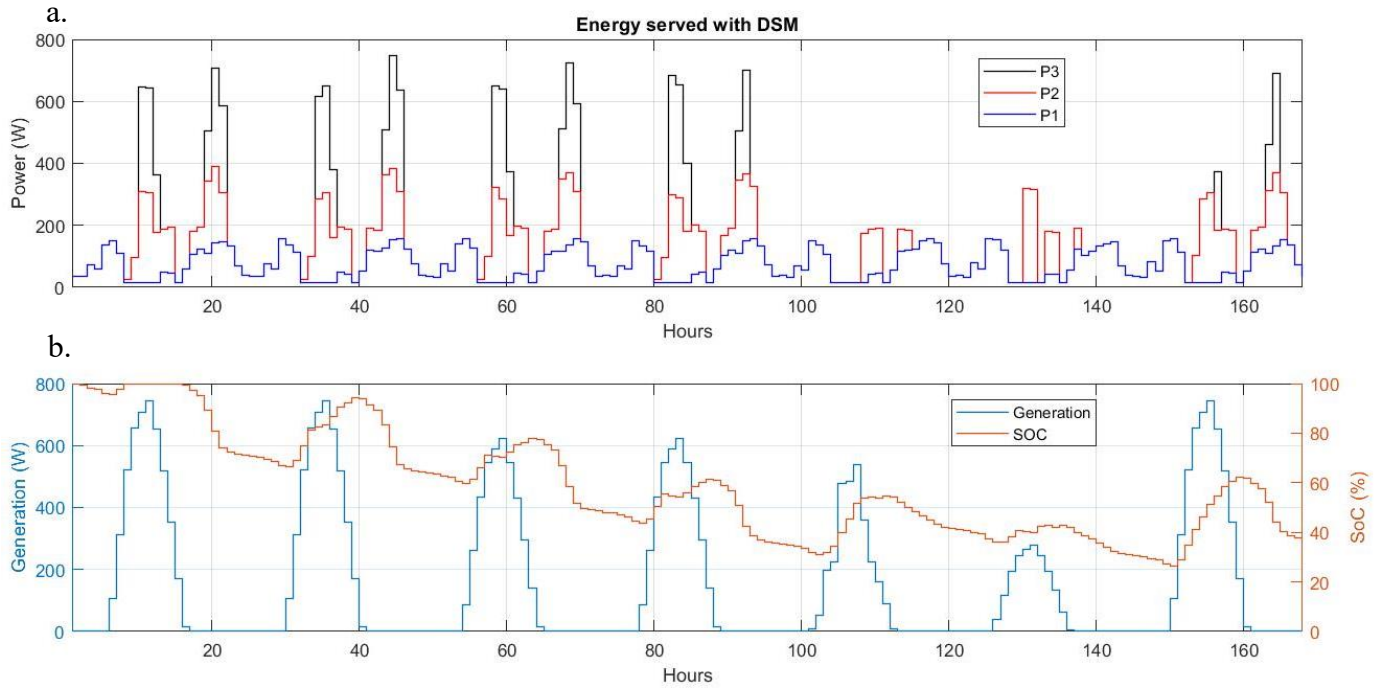

Figure 8(a): Energy served With DSM strategy, (b) Battery vs Generation

With the proposed DSM strategy the search algorithm finds the best point to shed loads on a different level. Figure 9 shows the total battery capacity allocated for each priority selected by the search algorithm for 7 days. On day 1, the algorithm allocates 30% of the battery till the least priority load is shedded (i.e., all three-priority load can be served until the battery reaches 70% of its total capacity), so the level one shedding is done when SoC reaches 70% and level 2 when SoC reaches 60%. High variation of energy allocation can be observed on the 5th day of the simulation as with lower generation, the least energy is allocated for load with lower priority as level 1 shedding is triggered at 90% SoC followed by the shedding level 2 when SoC reaches 50%. Such that during lower generation days the algorithm shed the lower priority load allocating remaining stored energy to medium and higher priority loads.

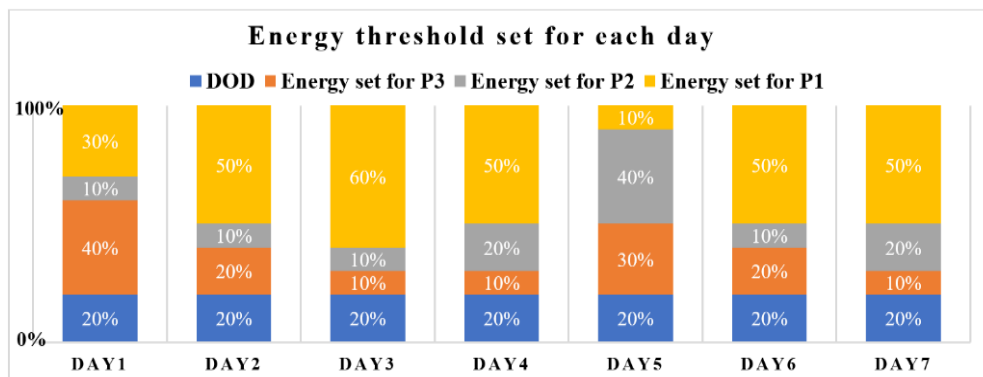

Figure 9: Energy Allocation for each priority level on each day

The energy allocation is based on maximizing user satisfaction to implement the search algorithm, and the priority percentage for the given load demand is calculated using Equation 3. Based on the demand detail with total energy served, the priority percentage is calculated to be 0.57, 0.24, and 0.08 for highest, medium, and lowest priorities. A comparison of the day-to-day user satisfaction obtained for each day is shown in Figure 10. When DSM is not implemented the system retains 55% user satisfaction on the days with the lowest generation. However, the satisfaction DSM comes at a price as the system face blackout up to 12 hours on

the sixth day. Along with 21 hours of total interruption period in supply comprising of 5 hours in day 5 and 4 hours in day 7. With the implementation of the proposed DSM strategy, the user satisfaction of energy supply is maintained at 70% even during the sixth day. As the load with higher priority served throughout 7 days, with proper prioritization of load, the approach can maintain continuity in the supply while maintaining user satisfaction of the customer.

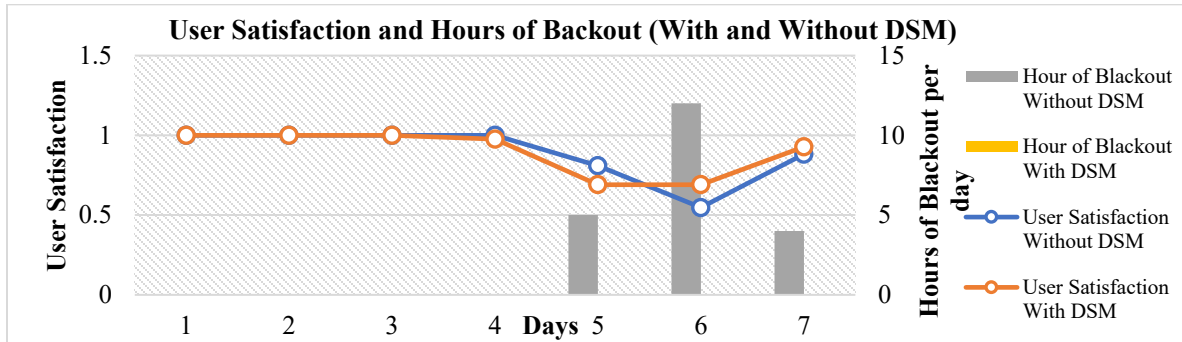

Figure 10: User satisfaction and Hours of blackout

Comparing the system load-served by the system with and without DSM strategy, the system faces multiple blackouts as seen in Figure 11(a). As it is seen in Figure 12, with the implementation of the load management technique, the system allocates enough energy to serve load with higher priority as demand on load 1 is completely served followed by load 2 and finally load 3 with the least priority. Comparison between these two cases shows that the load with lower priority has higher energy served when DSM is not implemented as a higher priority load is not served which affects user satisfaction.

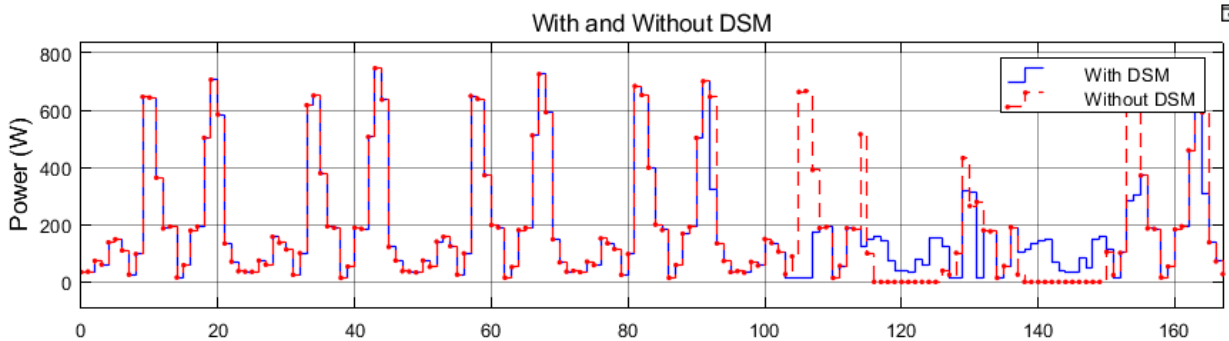

Figure 11: With and Without DSM

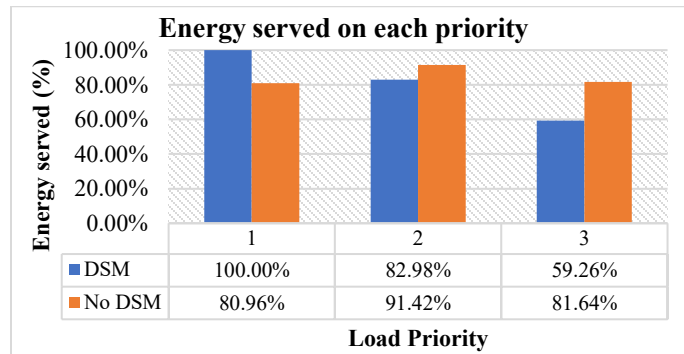

Figure 12: Energy served on each priority

Table 5 shows that the total blackout of the system can be reduced in the residential area of rural communities with the implementation of the priority-based DSM strategy. The proposed strategy can benefit both the consumers and the utility companies by avoiding blackouts such that the system can maintain user satisfaction and avoid battery from complete discharge. Comparing the system with and without the DSM strategy, it observes the random distribution of energy for the system without the DSM. When load management is not used, a rule of first come first serve is implied, where the priority or appliances turned

on first consume the available energy until it is turned back off or battery drains out. With the implementation of this strategy, users are allowed to prioritize the load as in case the system is unable to generate enough energy, the system stores enough energy for higher-priority load by turning off lower priority load. In terms of user satisfaction, the system obtained 89% total user satisfaction as shown in Table 3. The algorithm reduces the total blackout time of the system from 21 hours to zero hours for the highest priority load and increases user satisfaction by 5%.

Table 5: Data analysis for overall user satisfaction

| Priority level | Total demand hours | Priority percentage based on hours (x, y, z) | Energy demand kWh | Energy served with DSM | User satisfaction per priority (with DSM) | Energy served without DSM | User satisfaction per priority (without DSM) |
|--------------------------|--------------------|--|-------------------|------------------------|---|---------------------------|--|
| 1 | 168 | 0.57 | 12.13 | 12.13 | 0.57 | 9.82 | 0.46 |
| 2 | 84 | 0.29 | 13.11 | 10.87 | 0.24 | 11.98 | 0.26 |
| 3 | 42 | 0.14 | 12.05 | 7.14 | 0.08 | 9.84 | 0.12 |
| User Satisfaction | | 100% | | | 89% | | 84% |

4. CONCLUSION

DSM technique can improve the quality of energy supply in many ways, especially in residential locations. This paper presents a priority-based DSM technique that can be employed in the MGs, where energy crisis occurs due to high demand. Considering the rural MGs with the limited generation, this strategy presents the priorities of the appliance for curtailment to minimize the hours of blackout. Further, to improve the system limits and the calculation complexity, the appliance in the residential household are classified into a three-priority level. The simulation shows the effectiveness of the proposed prioritization technique, and the total hours of load serve have been improved for the appliance with higher priority. The system has improved user satisfaction by 5% by reducing the blackout of essential load, faced by the system from 21 hours to zero hours in the taken period of seven days.

The implementation of the priority concept on load can be further furnished with a proper study of load profile on appliances level. With accurate and detailed data on appliance-based load consumption, the priority implementation can be done with more accuracy. In addition, in the presented method, priority classifications are done on three levels to avoid complexity. Therefore, considering the system capability, the priority level can be increased or decrease or even modified to the shifting of loads for better service hours based on the capacity of the energy system, and to remove the blackout or/ and interruption to/ from the system.

Acknowledgement

This study was supported by the EnergizeNepal Project Office, Kathmandu University, Nepal (PID: ENEP-RENP-II-19-03). The authors like to acknowledge the Department of Electrical and Electronics Engineering, Kathmandu University, and Center for Electric Power Engineering (CEPE), Kathmandu University to provide the requested information, laboratory supports, and kind cooperation during the research work.

References

- [1] P. Palensky and D. Dietrich, "Demand side management: Demand response, intelligent energy systems, and smart loads," *IEEE transactions on industrial informatics*, vol. 7, no. 3, pp. 381-388, 2011.
- [2] H. Mortaji, S. H. Ow, M. Moghavvemi, and H. A. F. Almurib, "Load shedding and smart-direct load control using internet of things in smart grid demand response management," *IEEE Transactions on Industry Applications*, vol. 53, no. 6, pp. 5155-5163, 2017.
- [3] M. Pipattanasomporn, M. Kuzlu, S. Rahman, and Y. Teklu, "Load profiles of selected major household appliances and their demand response opportunities," *IEEE Transactions on Smart Grid*, vol. 5, no. 2, pp. 742-750, 2013.
- [4] M. Ali, M. F. Zia, and M. W. Sundhu, "Demand side management proposed algorithm for cost and peak load optimization," in *2016 4th International Istanbul Smart Grid Congress and Fair (ICSG)*, 2016, pp. 1-5: IEEE.
- [5] T. Logenthiran, D. Srinivasan, and T. Z. Shun, "Demand side management in smart grid using heuristic optimization," *IEEE transactions on smart grid*, vol. 3, no. 3, pp. 1244-1252, 2012.
- [6] A. Hoffman, "Peak demand control in commercial buildings with target peak adjustment based on load forecasting," in *Proceedings of the 1998 IEEE International Conference on Control Applications (Cat. No. 98CH36104)*, 1998, vol. 2, pp. 1292-1296: IEEE.
- [7] A. Shrestha *et al.*, "Peer-to-Peer Energy Trading in Micro/Mini-Grids for Local Energy Communities: A Review and Case Study of Nepal," *IEEE Access*, vol. 7, pp. 131911-131928, 2019.

- [8] A. Shrestha, Y. Rajbhandari, and N. Khadka, "Status of Micro/Mini-Grid Systems in a Himalayan Nation: A Comprehensive," *IEEE Access*, vol. 8, pp. 120983-120998, 2020.
- [9] P. Shrestha, A. Shrestha, N. T. Shrestha, A. Papadakis, and R. K. Maskey, "Assessment on Scaling-Up of Mini-Grid Initiative: Case Study of Mini-Grid in Rural Nepal," *International Journal of Precision Engineering and Manufacturing-Green Technology*, pp. 1-15.
- [10] AEPC, "Progress at a Glance: A Year in Review," Alternative Energy Promotion Center, Progress Report 2018/19.
- [11] B. Shakya, A. Bruce, and I. MacGill, "Survey based characterisation of energy services for improved design and operation of standalone microgrids," *Renewable and Sustainable Energy Reviews*, vol. 101, pp. 493-503, 2019.
- [12] B. Shakya, A. Bruce, and I. MacGill, "Micro Hydro Interconnected Mini Grids in Nepal: Potential and Pitfalls," *Asia Pacific Solar Research Conference, Brisbane Queensland*, 2015.
- [13] A. Shrestha *et al.*, "Assessment of electricity excess in an isolated hybrid energy system: A case study of a Dangiwada village in rural Nepal," *Energy Procedia*, vol. 160, pp. 76-83, 2019.
- [14] S. Sah, A. Shrestha, and A. Papadakis, "Cost-effective and reliable energy system for Kathmandu University complex," in *Proceedings of the 11th International Conference on Deregulated Engineering Market Issues, Nicosia, Cyprus*, 2018, pp. 20-21.
- [15] A. Shrestha, A. Singh, K. Khanal, and R. Maskey, "Potentiality of off-grid hybrid systems for sustainable power supply at Kathmandu University campus," in *2016 IEEE 6th International Conference on Power Systems (ICPS)*, 2016, pp. 1-6: IEEE.
- [16] A. Bista, N. Khadka, A. Shrestha, and D. Bista, "Comparative analysis of different hybrid energy system for sustainable power supply: A case study," *E&ES*, vol. 463, no. 1, p. 012045, 2020.
- [17] P. Shrestha, A. Shrestha, and B. Adhikary, "Comparative analysis of grid integration on distributed energy system," in *Proceedings of the 5th International Conference on Developments in Renewable Energy Technology, Kathmandu, Nepal*, 2018, pp. 29-31.
- [18] R. Ramanathan, R. Engle, C. W. Granger, F. Vahid-Araghi, and C. Brace, "Short-run forecasts of electricity loads and peaks," *International journal of forecasting*, vol. 13, no. 2, pp. 161-174, 1997.
- [19] K. Chapagain and S. Kittipiyakul, "Performance analysis of short-term electricity demand with atmospheric variables," *Energies*, vol. 11, no. 4, p. 818, 2018.
- [20] W. Fung, K. S. Lam, W. Hung, S. Pang, and Y. Lee, "Impact of urban temperature on energy consumption of Hong Kong," *Energy*, vol. 31, no. 14, pp. 2623-2637, 2006.
- [21] A. Maheshwari, K. K. Murari, and T. Jayaraman, "Peak Electricity Demand and Global Warming in the Industrial and Residential areas of Pune: An Extreme Value Approach," *arXiv preprint arXiv:1908.08570*, 2019.
- [22] P. Rijal. (2019, 1 August 2019). *Nepali are consuming 38 percent more electricity than two years ago*. Available: <https://kathmandupost.com/money/2019/07/31/nepalis-are-consuming-38-percent-more-electricity-than-2-years-ago>
- [23] H. Kobayashi, J. Acharya, H. Zhang, and P. Manandhar, "Nepal Energy Sector Assessment, Strategy, and Road Map," *Asian Development Bank*, vol. 6, 2017.
- [24] P. Kumar, T. Yamashita, A. Karki, S. Rajshekar, A. Shrestha, and A. Yadav, "Nepal-Scaling up electricity access through mini and micro hydropower applications: a strategic stock-taking and developing a future roadmap," *World Bank, Washington, DC*, <http://documents.worldbank.org/curated/en/650931468288599171/Nepal-Scaling-up-electricity-access-through-mini-and-micro-hydropower-applications-a-strategic-stock-takingand-developing-a-future-roadmap>, 2015.
- [25] A. Khan, N. Javaid, M. N. Iqbal, N. Anwar, and F. Ahmad, "Time and device based priority induced demand side load management in smart home with consumer budget limit," in *2018 IEEE 32nd international conference on Advanced Information Networking and Applications (AINA)*, 2018, pp. 874-881: IEEE.
- [26] T. Ayodele, A. Ogunjuyigbe, K. Akpeji, and O. Akinola, "Prioritized rule based load management technique for residential building powered by PV/battery system," *Engineering science and technology, an international journal*, vol. 20, no. 3, pp. 859-873, 2017.
- [27] A. Hooshmand, M. H. Poursaeidi, J. Mohammadpour, H. A. Malki, and K. Grigoriads, "Stochastic model predictive control method for microgrid management," in *2012 IEEE PES Innovative Smart Grid Technologies (ISGT)*, 2012, pp. 1-7: IEEE.
- [28] Y. Riffonneau, S. Bacha, F. Barruel, and S. Ploix, "Optimal power flow management for grid connected PV systems with batteries," *IEEE Transactions on sustainable energy*, vol. 2, no. 3, pp. 309-320, 2011.
- [29] A. Khalid, N. Javaid, A. Mateen, B. Khalid, Z. A. Khan, and U. Qasim, "Demand side management using hybrid bacterial foraging and genetic algorithm optimization techniques," in *2016 10th International Conference on Complex, Intelligent, and Software Intensive Systems (CISIS)*, 2016, pp. 494-502: IEEE.
- [30] A. K. Sharma and A. Saxena, "A demand side management control strategy using Whale optimization algorithm," *SN Applied Sciences*, vol. 1, no. 8, p. 870, 2019.

- [31] I. Zunnurain, M. Maruf, N. Islam, M. Rahman, and G. Shafiullah, "Implementation of advanced demand side management for microgrid incorporating demand response and home energy management system," *Infrastructures*, vol. 3, no. 4, p. 50, 2018.
- [32] T. Quetchenbach *et al.*, "The GridShare solution: a smart grid approach to improve service provision on a renewable energy mini-grid in Bhutan," *Environmental Research Letters*, vol. 8, no. 1, p. 014018, 2013.
- [33] S. Neupane and A. K. Jha, "Performance Evaluation of 18kW Solar Photovoltaic Baidi MicroGrid at Baidi, Tanahun, Nepal."
- [34] E. Ela, V. Diakov, E. Ibanez, and M. Heaney, "Impacts of variability and uncertainty in solar photovoltaic generation at multiple timescales," National Renewable Energy Lab.(NREL), Golden, CO (United States)2013.
- [35] P. Action, "Opportunities for Real-time Monitoring, Control and Payment Technologies for Mini-grids: A Case Study of Operational Systems in Nepal," 2016.



Yaju Rajbhandari received his Bachelor's Degree in Electrical and Electronics Engineering specialization in Power and control from Kathmandu University in the year 2018. He is currently enrolled in Kathmandu University doing his MS by Research Program in the field of Microgrid Control and Management alongside working as a Research Assistant in the University. His employment experience includes acting Plant Incharge in Panchakhanya Mai Hydropower Plant, Nepal. He was also an Erasmus Mundus candidate at the Department of Electrical Engineering, Frederick University, Cyprus in 2016. His research interest includes control and management of microgrid, smart grid technology, IoT base automation.



Anup Marahatta received his Bachelor's degree in Electrical and Electronics Engineering from Kathmandu University in 2019. His bachelors' thesis was on the design and implementation of SCADA for DC microgrid system. He is currently enrolled as a MS by research candidate with the role of Research Assistant under the Department of Electrical and Electronics Engineering, Kathmandu University. His research interests are Power Electronics, Microgrid Control Systems, Internet of Things and Robotics.



Ashish Shrestha received the Bachelor degree in Electrical and Electronics Engineering from School of Engineering, Pokhara University, Nepal and the Master degree in Planning and Operation of Energy System from School of Engineering, Kathmandu University, Nepal. He was also an Erasmus Mundus candidate at Department of Electrical Engineering, Frederick University, Cyprus, funded by European Union. Currently, he is doing his PhD at Department of Electrical Engineering, Information Technology and Cybernetics, University of South-Eastern Norway, Porsgrunn Campus, Norway. Before his PhD, he was working as a Lecturer at the Department of Electrical and Electronics Engineering, and a Researcher (Activity Leader) at Center for Electric Power Engineering (CEPE), Kathmandu University, Nepal for three and half years. He was also involved in the problem-based-learning project funded by Erasmus+ program of EU. Currently, he is leading a project under the funding of Ministry of Foreign Affairs (MFA), Norway, as the Project Co-Principal Investigator. Till today, he published around 29 peer-reviewed journal articles and international conference papers and was assigned as a reviewer for numerous international conferences and peer-reviewed journals from IEEE, Springer, Elsevier, IET and so on. His research interests include Power System Dynamics, Distributed Generation Resources, Planning and Operation of Energy System and Electric Vehicle.



Ananda Gacchadhar did his Bachelor degree in Electronics and Communication Engineering from Tribhuvan University, Nepal, and Master degree from Anna University, India. Currently, he is working as an Assistant Professor at Department of Electrical and Electronics Engineering, Kathmandu University from 2012. He teaches Wireless Communication and Data Communication and his research interests includes wireless sensor networks and 5G networks. Currently, He is working on power optimization and interference cancellation issue on heterogeneous networks.



Anup Thapa is an active researcher, with more than ten years of research experience, in the field of wireless communication and networking. Currently, he is working as Assistant Professor at the Department of Electrical and Electronics Engineering, School of Engineering, Kathmandu University (KU), Nepal. Previously, before joining KU, he was working as a post-doctorate researcher in UWB Wireless Communications Research Center, Department of Information and Communication, Inha University, Incheon, Korea. Dr. Thapa has received PhD in computer engineering (with a concentration in wireless communication and networking) from Chosun University (alumni:whynet lab), Gwangju, Korea, in 2013. His research interest includes MAC layer protocol design for various wireless networking technologies including WMAN, WLAN, WPAN, and WBAN. Besides these, self-organizing networks, femtocell deployed broadband access, Multi-user MIMO system, high-efficiency network, and internet of things belong to his field of interest.



Francisco Gonzalez-Longatt (M'94- SM'09) is currently a full professor in electrical power engineering at Institutt for elektro, IT og kybernetikk, Universitetet i Sørøst-Norge, Norway. His research interest includes innovative (operation/control) schemes to optimize the performance of future energy systems. He has prolific research productivity including several industrial research projects and consultancy worldwide. Also, he is the author or editor of several books (Spanish and English), associated editor in several journals with an impressive track record on scientific publications. Prof. Gonzalez-Longatt is Vice-President of Venezuelan Wind Energy Association, a member of The Institution of Engineering and Technology - The IET (UK) and a member of International Council on Large Electric Systems - CIGRE. He received the professional recognition as FHEA - Fellow of the Higher Education Academy in January 2014.



Josep M. Guerrero received the B.S. degree in telecommunications engineering, the M.S. degree in electronics engineering, and the Ph.D. degree in power electronics from the Technical University of Catalonia, Barcelona, in 1997, 2000 and 2003, respectively. Since 2011, he has been a Full Professor with the Department of Energy Technology, Aalborg University, Denmark, where he is responsible for the Microgrid Research Program. From 2014 he is chair Professor in Shandong University; from 2015 he is a distinguished guest Professor in Hunan University; and from 2016 he is a visiting professor fellow at Aston University, UK, and a guest Professor at the Nanjing University of Posts and Telecommunications. He is a founder and director of Center for Research on Microgrids (CROM). His research interests is oriented to different microgrid aspects, including power electronics, distributed energy-storage systems, hierarchical and cooperative control, energy management systems, smart metering and the internet of things for AC/DC microgrid clusters and islanded minigrids. Specially focused on microgrid technologies applied to offshore wind, maritime microgrids for electrical ships, vessels, ferries and seaports, and space microgrids applied to nanosatellites and spacecrafts. Prof. Guerrero is an Associate Editor for a number of IEEE TRANSACTIONS. He has published more than 1300 journal papers and conference with more than 56,000 citations. He received the best paper award of the IEEE Transactions on Energy Conversion for the period 2014-2015, and the best paper prize of IEEE-PES in 2015. As well, he received the best paper award of the Journal of Power Electronics in 2016. During six consecutive years, from 2014 to 2020, he was awarded by Clarivate Analytics (former Thomson Reuters) as Highly Cited Researcher with 50 highly cited papers. In 2015 he was elevated as IEEE Fellow for his contributions on “distributed power systems and microgrids.”



Petr Korba received his Dipl.-Ing. degree in electrical engineering from the Czech Technical University, Prague, Czech Republic, in 1995 and his Dr.-Ing. Degree from the University of Duisburg, Germany, in 1999. He then became a member of academic staff at the University of Manchester, Institute of Science and Technology where he stayed until 2001 when he joined ABB Switzerland Ltd. He held different positions in the business unit Power system automation and he worked later for more than 10 years as a principal scientist at ABB Corporate Research Ltd. Since 2008 he has been a lecturer at ETH Zurich. He became a professor of electric power systems at the Zurich University of applied sciences in 2012 where he is the head of electric power systems group and the deputy head of the institute of energy systems and fluid engineering. He is also the co-director of the Swiss Competence Centre of Energy Research (SCCER, Grids & Components).